

Technical Report -2

Application of the Optical Floating Zone
Apparatus for Researching Material Sciences

Part-1

Practice of Single Crystal Growth
Using Optical Floating Zone Furnaces

Crystal Systems Corp.

〒408-0011 Kobuchisawa 9633 Yamanashi 408 Japan

TEL:+81-551-36-5271 FAX:+81-551-36-5273

The optical floating zone furnace has a wide range of applications for the study of both single crystal growth and phase diagram. This type of furnace needs no crucibles, therefore, the chemical reaction between the melt and the crucible material should be avoided. Also this type of furnace should achieve the traveling solvent scheme which is needed for growing incongruently melting materials and solid solution with uniform compositions.

During the past 20 years, many successful results have been reported, and many high-quality single crystals have been grown. This report presents detailed procedures for growing single crystals for younger researchers who wish to grow their own single crystals for the first time.

It is safe to say that the growth of single crystals in an optical floating zone furnace is influenced by the following elements;

Feed rod	50% (almost half)
Furnace	25% (quarter)
Conversation	25% (quarter)

Feed rod

In the growth of single crystals by the floating zone method, the molten zone is sustained by the feed rod through the surface tension, therefore, the qualities of the feed rod are very important and have a strong influence on the stability and successful formation of the molten zone. Thus, a great deal of effort has to be made to create a straight and uniform diameter rod.

Furnace

The quality of furnace is also important as stable and uniform temperature conditions have to be kept throughout the growth of crystals. The four mirror type furnace can achieve such temperature conditions and can grow high-quality single crystals.

Conversation

This conversation means that the crystal grower has to talk " with material itself and find its suitable growing conditions.

CONTENTS

Part-1 Practice of the single crystal growth by the optical floating zone furnace

1. Introduction	2
2. Flow chart of growing procedure	4
3. Preparation of starting powders	5
3.1 Measure the ignition loss	5
3.2 Weighing	5
3.3 Mixing	5
3.5 Drying	5
4. Preparation of feed rod	5
4.1 Packing	5
4.2 Hydrostatic pressing	6
4.3 Make a hole	7
4.4 Sintering	7
5. Growth procedure	8
5.1 Growth of congruently materials	8
5.2 Growth of peritectic materials	9
5.2.1 Measure the composition and volume of molten zone	10
5.2.2 Practice of the growth using molten zone rod	11

2. Flow chart of the growth of single crystals using optical floating zone furnace.

Items	Using tools	Remarks
Ignition loss measurement	Thermo-balance Platinum crucible	
Measure the weight	Balance	
Mixing	Alumina crucible	
Drying	Drier	
Packing (in rubber tube)	Rubber tube	
Air exhaust	Air exhauster	
Pressing	Hydrostatic press	HS-M-1
Wiring	Drill(1mm), Platinum wire	
Sintering	Vertical furnace Rotating lifter	
Crystal Growth	Floating zone furnace Circulating chiller Mass flow controller Turbo vacuum exhauster	FZ-T-4000-H FZ-T-10000-H FZ-T-12000-X
Direction measurement	X-ray Laue method	
Cutting	Fine cutter	CU-M-1
Polishing	Fine polisher	TP-01

3. Preparation of starting powders

3.1 Measurement of ignition loss of the powders

In the floating zone method using optical image furnaces, the volume of the molten zone must be limited by its surface tension. Also the composition of the starting powders has to be correct, therefore, ignition loss of the powders has to be measured.

3.2 Weighing

An accuracy of 0.01 % is needed, and it is always necessary to watch the change in the ignition loss value. In the case of the floating zone method, the volume of the molten zone is much less than that of Czochralski pulling

method, therefore, small compositional changes have a greater influence on the results.

3.3 Mixing

The wet method of mixing is suitable for reducing the mixing time. Normally, ethyl-alcohol is added and mixed for approximately 2 hours.

3.4 ..Drying

4. Preparation of the sintered rod

4.1 Packing

Starting powders are packed into the rubber tube with an appropriate diameter and length. After packing the powders, the packed rubber tube is pressed by the hydrostatic method.

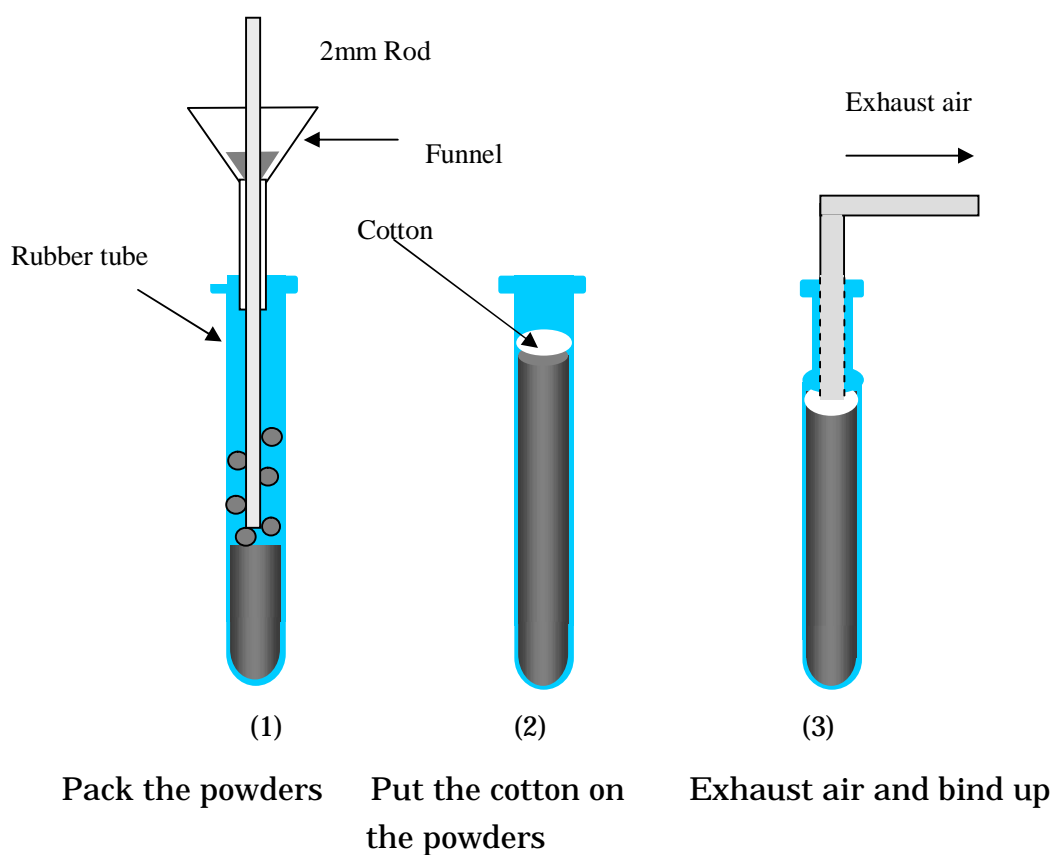

Fig 1. Procedure for packing powders in a rubber tube

4.2 Pressing

The packed rubber tube is pressed by the hydrostatic press method using water. In most cases, the oil pressure of the hand press is at $700\text{kg}/\text{cm}^2$, therefore, the rubber tube will be pressed at approximately $2,000\text{kg}/\text{cm}^2$

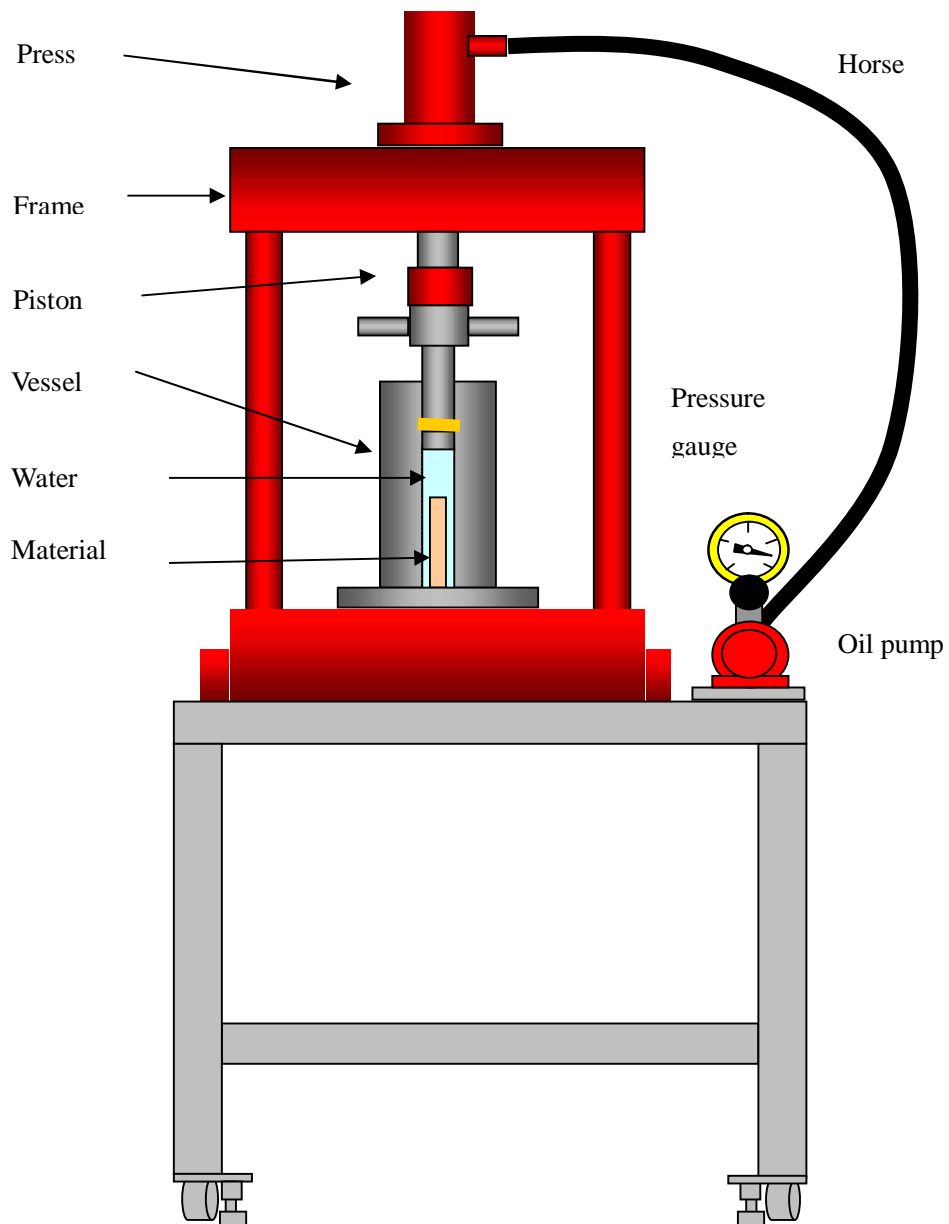

Fig 2. Procedure for packing powders in a rubber tube

The packed rubber tube is inserted into the vessel, which is filled with water, then pressed hydrostatically by using the oil press.

4.3 Drilling

After being pressed, the pressed bar is separated from the rubber, and a small hole of 1mm diameter is bored using a 1mm diameter hand drill.

Thread the small diameter platinum wire through this small hole, and make a loop as shown in fig.3(right) The pressed bar is easily broken at this stage, so this process must be done carefully.



Bore a hole using drill
(diameter ~ 1mm)



Thread the platinum wire

4.4 Sintering

Hang the pressed bar using the loop on the hook at the bottom of the alumina ceramic bar of the rotating lifter and insert into the electric furnace. In order to make a rod which is straight and of uniform density, the bar has to be rotated continuously, and be moved up and down to achieve the same temperature history. The interval time and number of repeating up-and-down are set, and then start the sintering.

Atmospheric gas is introduced into the furnace from the bottom. The top of the ceramic tube is covered by two halved ceramic plates to keep the good atmospheric condition.

After the repeat of moving up-and-down according to the desired interval, the sintered rod will be moved to the top position automatically.

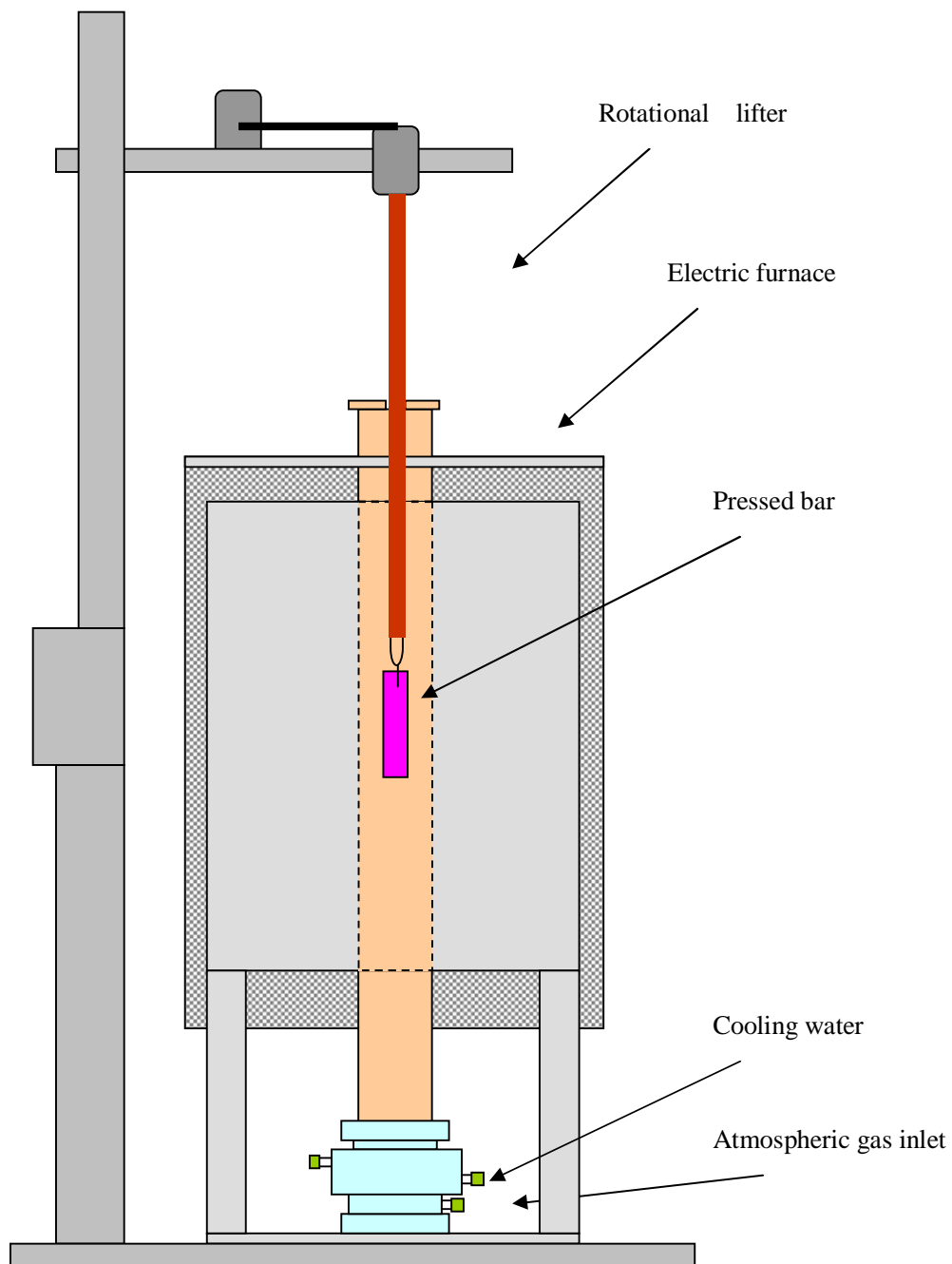

Fig 4. Sintering of the pressed bar under desired atmospheric gas.

During the sintering process, the bar has to be continuously rotated and be moved up and down in order to avoid vanding and local sintering of the bar. A straight and uniform sintered rod is needed to achieve and keep a stable floating zone.

5. Crystal Growth

The growth of single crystals by the floating zone method is considered as the melt growth method; however, if the material melts incongruently, the scheme of the growth will be drastically different from the normal congruently melting compounds.

5.1 Growth of congruently melting compounds

1) Seed

In many cases of growth, a single crystal is not prepared as the seed. Therefore, the sintered rod should be used as the seed.

When a polycrystalline sintered rod is used as the seed, grains will be generated, however, after 30-40 mm length progression, grain will be decreased gradually. Finally, these grains will become as seed single in some cases (in the case of $Y_3Fe_5O_{12}$, Li_2O , for example).

Seed crystal or rod has to be fixed using nickel wire to the ceramic seed holder.

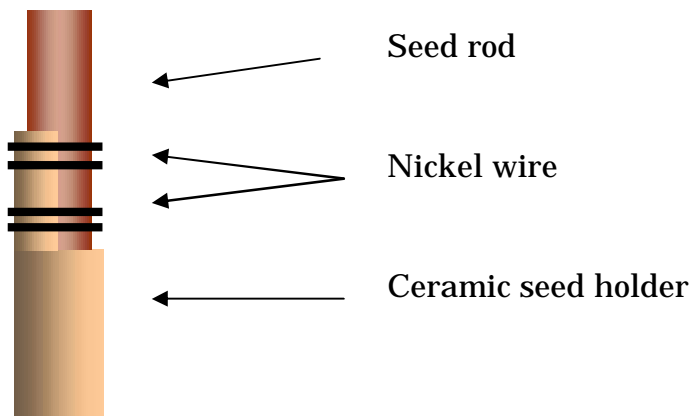

Fig 5. Seed rod and its holder

2) Feed rod

The feed rod is hung from the hook of the upper shaft by the platinum wire loop as seen in Fig.6 . This procedure seems to be “rough” and “uncertain”, however, it will be more safe way because if the feed rod is fixed to the upper shaft, the rod will be easily broken when it contacts with the seed rod during the growth.

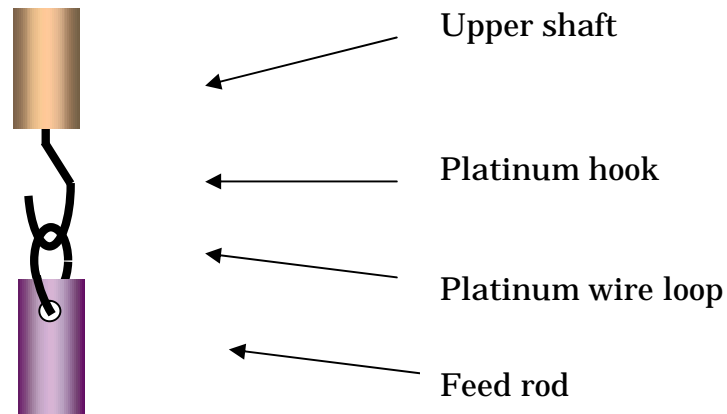

Fig 6. Hang the feed rod to the hook of the upper shaft.

3) Length of the molten zone

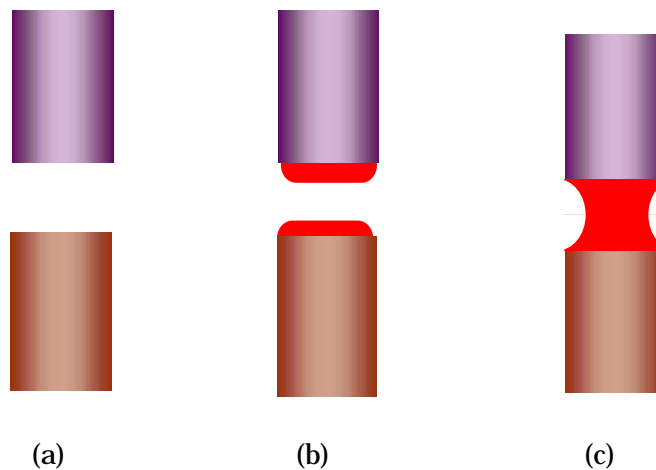

Fig 7. Length of the molten zone

At the first stage of the heating, both the feed and seed rod are set separately having a few mm distance (Fig. 7a). As the heating progresses, both ends of the feed and seed rod will begin to melt (Fig 7b). At this point, the upper feed rod is moved downwards until it touches the seed rod. Finally, the length of the molten zone is adjusted, so its diameter will be almost the same size as that of the seed rod (Fig 7c).

4) Rotation rate

In normally, both the upper and the lower shaft should be rotated in opposite direction at a rate of 30 – 50 rpm. A large rotation rate can mixing the molten zone and can keep homogeneous compositional condition which would be good effect to avoid the cellular growth patterns. Furthermore, a large rotation rate has an effect to decrease the convexity of the solid liquid interface and can keep the stable molten condition to avoid the touching of the upper feed rod and the lower grown crystal.

(ref. Kitamura et al, J. crystal Growth 46 (1979) 277,)

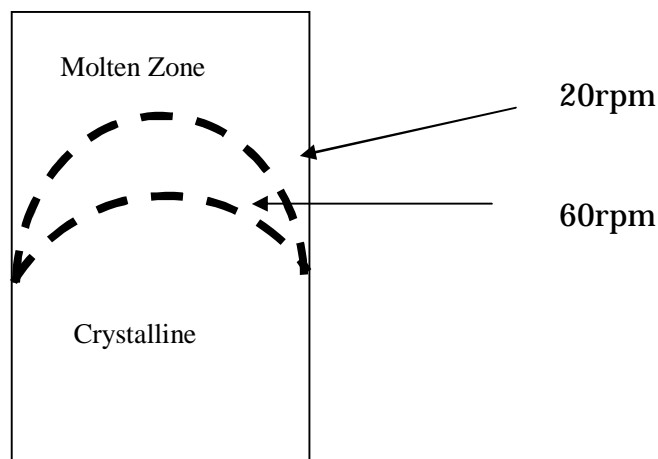

Fig 8. Relation between interface shape and rotation rate.

5) Observation of the growth conditions

One of the most important advantages of the optical floating zone furnace is that the growth conditions can be observed very easily by using the CCD camera system during the growth.

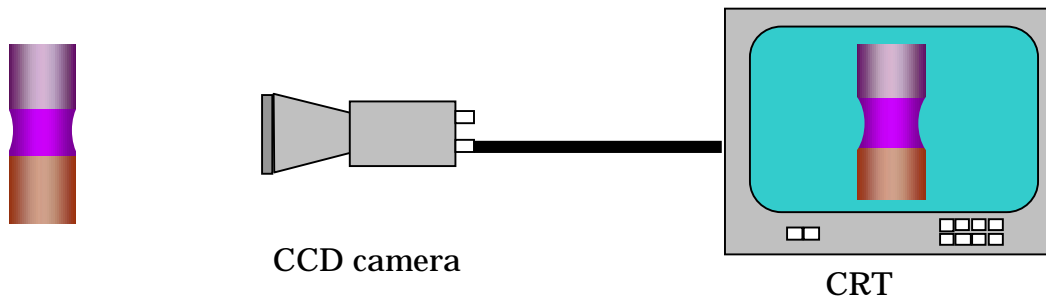

Fig 9. Schematic illustration of the observation system.

6) Grain boundary

In many cases, the shape of the solid-liquid interface is concave (Fig 10).

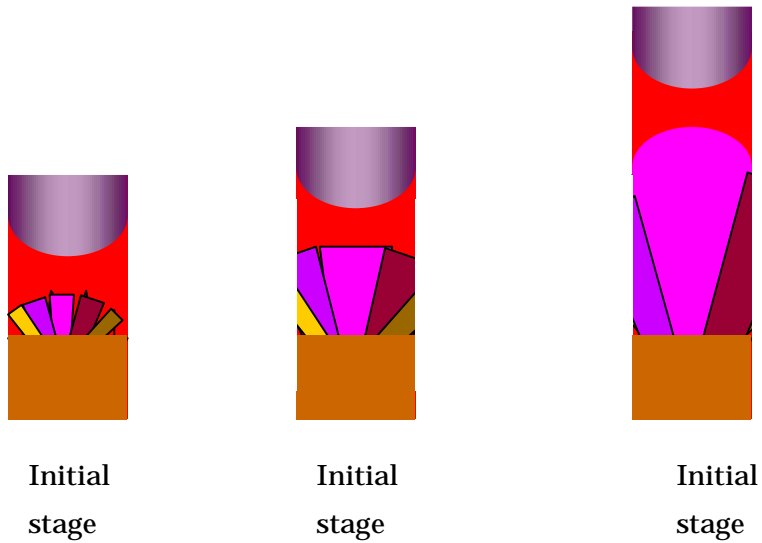

Fig 10. Schematic illustration of the grains.

In conclusion, the number of grains will be decreased, then a single grain (single crystal) will be obtained in some cases when a sintered polycrystalline rod is used as the seed. In such cases, the convex shape of the solid liquid interface is an important element to decrease the number of grains as the crystal growth proceeds.

5.2 The growth of incongruently melting or peritectic compounds

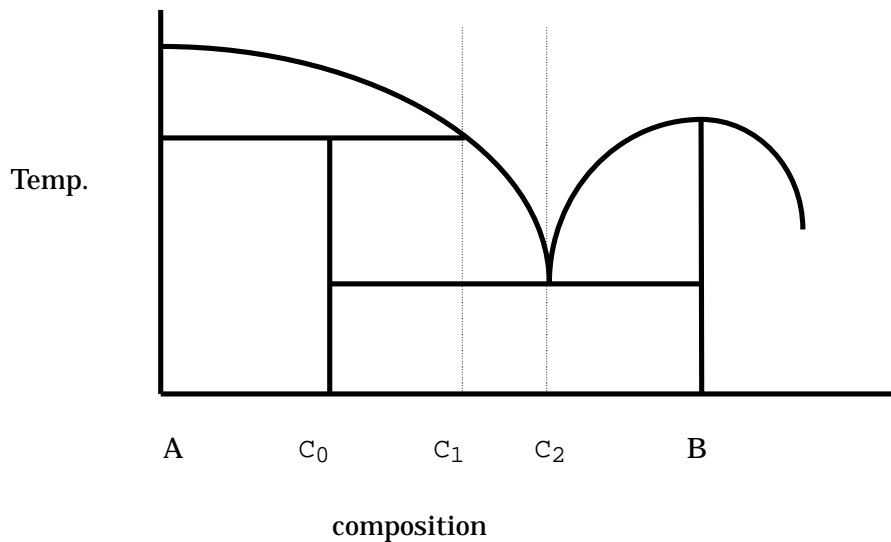

Fig 11. Schematic diagram including an incongruently melting compound.

An incongruently melting compound C_0 can be precipitated from a solvent of composition between C_1 and C_2 . Therefore, a traveling solvent scheme in which the feed is dissolved into solvent, and the relative proportions of crystal is precipitated from solvent, has to be kept during the growth.

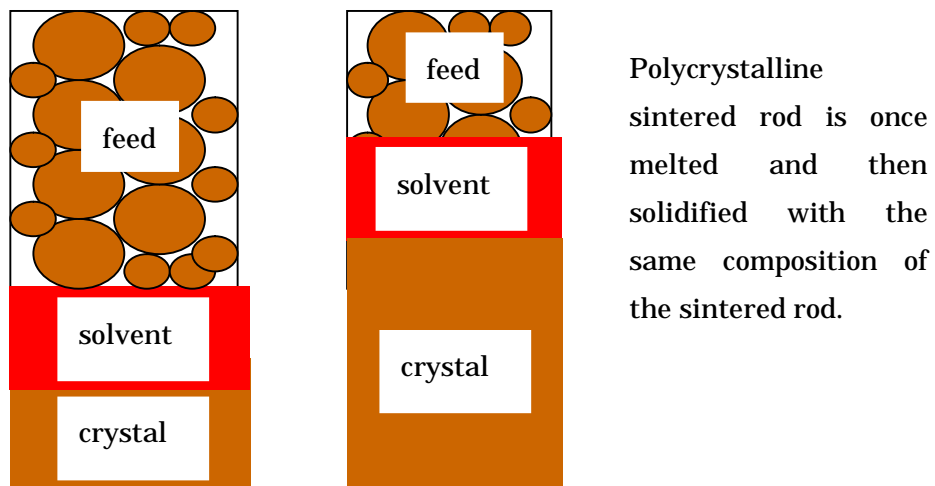

Fig 12. Schematic illustration of the traveling solvent floating zone method.

5.2.1 Measurement of the volume and the composition of the solvent

In order to grow a single and uniform compositional crystal of incongruently melting materials, the volume and the composition of the solvent zone under equilibrium condition has to be measured, and the chip having the measured volume and composition named as the solvent chip is set at the initial stage of the growth. In the first experiment, these values are not known, therefore, the growth is started without the solvent. After a 30-50mm long crystal is grown, all electric powers of the rotation shafts and halogen lamps are cut off to quench the molten zone.

The quenched bole is halved along the longitudinal direction. The volume of the quenched molten zone can be estimated, and its composition can be determined by an electron probe micro analyzer or other chemical methods.

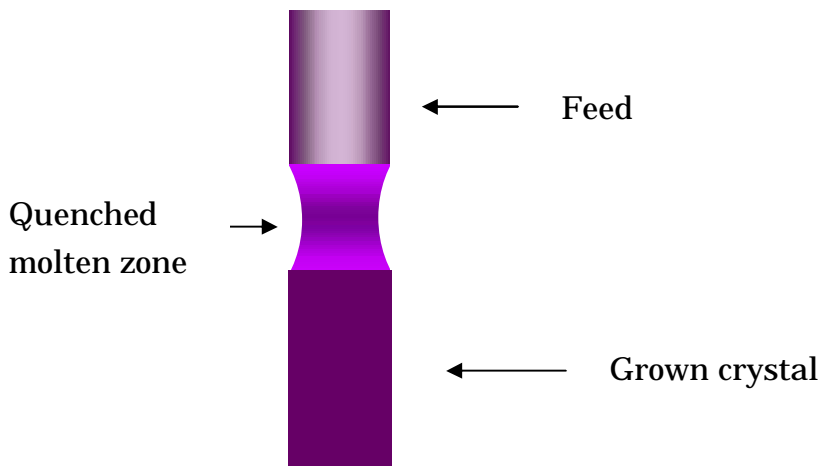

Fig 13. Halved bar after quenching

The quenched molten zone is very soft and easily collapses; therefore, organic resin would be very useful to fix it, and the corresponding procedures such cutting and polishing would become more easy and safety.

5.2.2 Growth of uniform compositional crystal using a solvent chip.

After the measurement of volume and composition of the molten zone, a sintered rod of this composition is made separately and is cut with the desired volume. This solvent zone chip is set on the top of the seed rod as shown in the following figure.

First, the top of the solvent chip and the bottom of the feed rod are

partially melted and connected. Then, the top of the seed rod and the bottom of the solvent chip are melted and connected. This procedure needs a very stable and uniform temperature condition around the horizontal plane. The four mirror image furnace can meet this requirement.

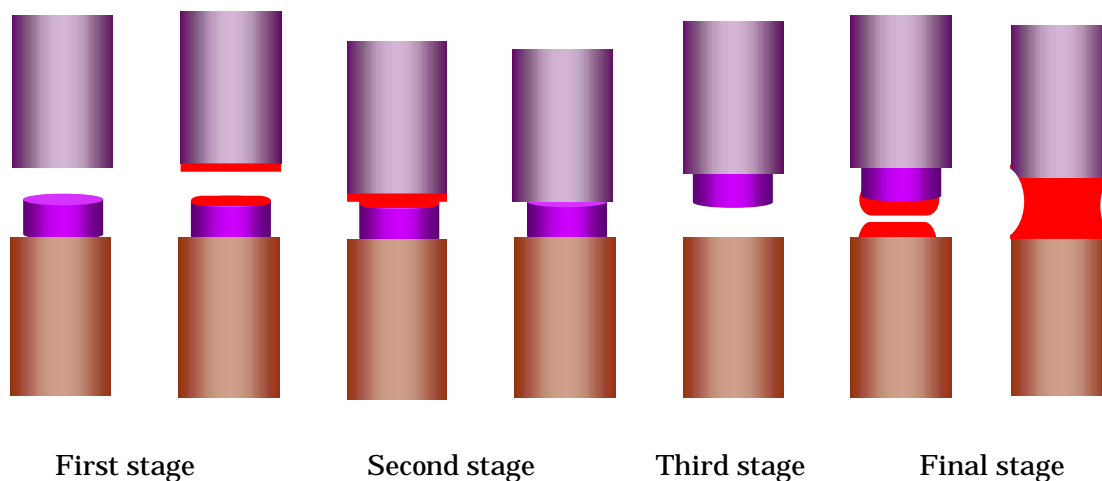

Fig 14. How to use the solvent zone chip

1) First stage

Set the solvent zone chip on the top of the seed rod. A small amount of starch paste can be used to fix it. The starch will be burnt off as the temperature increases, and a small amount of smoke will appear. If this smoke stains the center portion of the quartz tube, it can block off the light. Therefore, a larger amount of atmospheric gas (10 /min) has to be used to carry the smoke away from the center of the quartz tube.

2) Second stage

Both the top of the solvent zone chip and the end of the feed rod are partially melted, and connected without rotation of either the upper or lower shafts. After that, the lamp power will be slightly decreased and the upper shaft will be retracted to separate the solvent zone.

3) Third stage

Both the end of the solvent zone chip and the top of the seed rod are partially melted, and are brought into contact with rotation of both shafts.

3) Final stage

Adjust the lamp power to keep the molten zone stable and to melt a few millimeters of the top portion of the seed. After a few minutes, the crystal growth will begin.

5.2.3 Preparation of a solvent zone attached feed rod

The technique of the solvent zone chip described in former section requires much time and careful handling. The following simple technique will be more effective in some cases. Firstly the desired volume of the solvent zone material is put into a rubber tube for pressing, then the feed material is also put into the rubber tube as shown in the Fig.14. .After hydrostatic pressing, a feed rod with an attached solvent zone can be obtained.

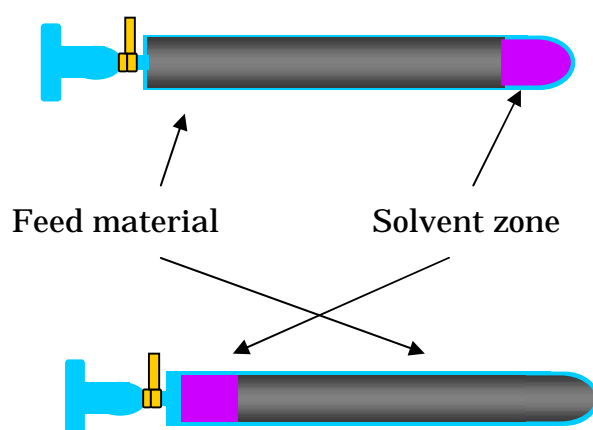

Fig 14. Feed rod attached solvent zone

Although this technique is simple and uncomplicated, it can only be applied to some specific cases in which the sintered temperature of the good quality feed rod is lower than that of the solvent zone material. In normally, the sintered temperature of the feed rod and the solvent zone material is not the same level, therefore, the feed rod and the solvent zone rod have to be made separately, and the proper amount of the solvent zone should be cut and used as the solvent chip which will be inserted into between the feed rod and the seed rod before melting.